

# CS-154/CS-304 Wide Range Speaker

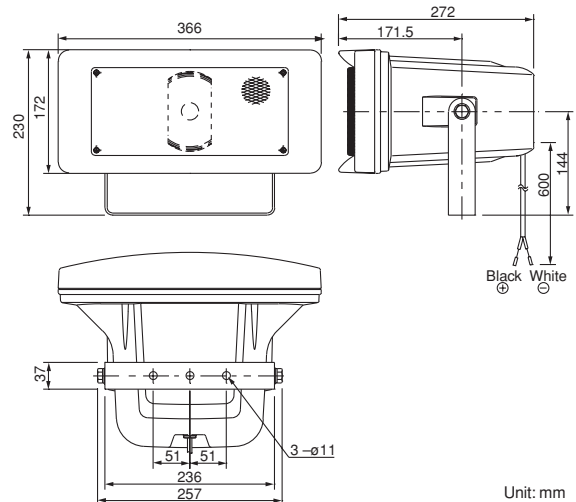

## APPEARANCE AND DIMENSIONAL DIAGRAM



## DESCRIPTION

TOA's CS-154 and CS-304 speakers are for outdoor-use, they use wide-range horns that can provide background music or paging announcements which have high quality sound. They are designed to produce high output with an increase of the speaker acoustic conversion efficiency, by the use of a horn in combination with a cone speaker. The CS-154 and CS-304 use constant directivity horns (90° horizontal) to control sound directivity, realizing uniform and clear sound dispersion over a wide area. These wide-range speakers are also designed to stand up to the rigorous weather conditions when installed outdoors.\* The speakers' ABS resin enclosure is light in weight, structurally strong and resistant to impacts. Since the enclosures are also treated with weatherproof polyurethane resin paint, they are extremely resistant to the effects of ultraviolet light. The speakers also comply with IP65 Standard requirements for dust proof and waterproof capabilities. In addition, the internal speaker parts feature a special weatherproof treatment to enhance the waterproof properties of the entire speaker. Stainless-steel brackets and screws further protect the unit from rust and corrosion. Speaker impedance can be easily changed externally with a rotary switch, facilitating changes in impedance during and after speaker installation.

CS-154: 15W/10W/5W (100V line) and 15W/7.5W/5W/2.5W (70V line)

CS-304: 30W/20W/10W (100V line) and 30W/15W/10W/5W (70V line)

## FEATURES

- Wide-range paging speaker for voice paging, background music and tone signaling distribution.
- Constant directivity horn improves directivity characteristics and ensure uniform and clear sound dispersion.
- High sensitivity: up to 98 dB (1W/1m)
- Weatherproof polyurethane resin paint permits the speaker to withstand demanding environmental conditions.\*
- IP65 standard compliant.
- Lightweight ABS resin enclosure that is mechanically strong and resistant to impact.
- Stainless steel hardware protects the speaker from corrosion.
- Stainless steel mounting bracket for easy installation and aiming in wall, pole or ceiling-mount applications.
- Ideal for schools, parking facilities, boats, industrial, parks, swimming pools, and so on.

\* Do not install the speaker face-up from a horizontal plane nor in such a way that the paper cone is exposed to direct sunlight.

If water accumulates on the paper cone, or ultraviolet rays are radiated on it, this may cause the paper cone to deteriorate, leading to speaker malfunction.

## Wiring Diagram

### CS-154

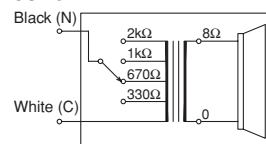

### CS-304

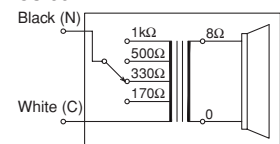

(Transformer connection when the speaker is supplied from the factory)



# CHARACTERISTIC DIAGRAMS

CS-154

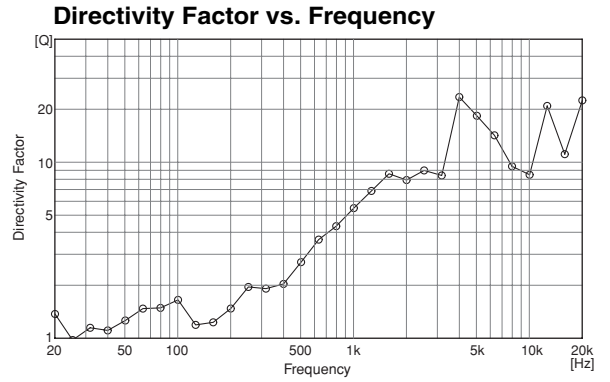
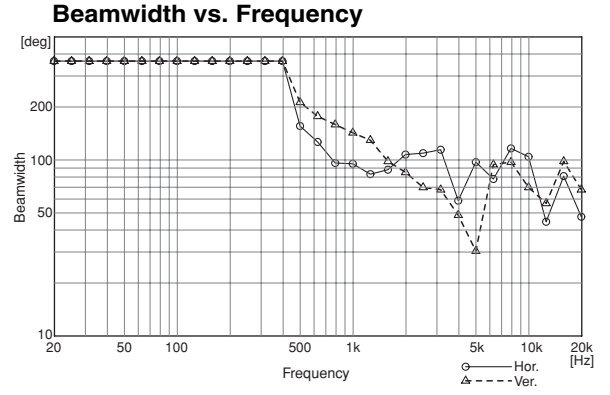
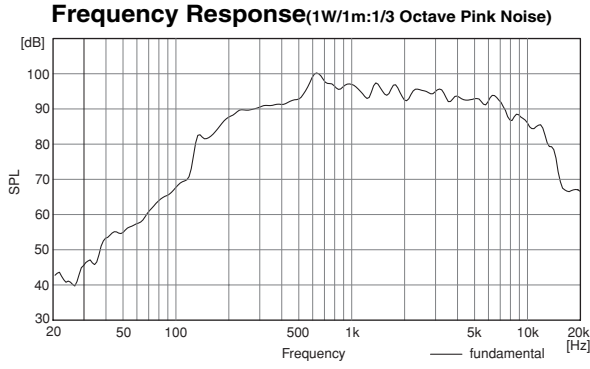

## Polar Response

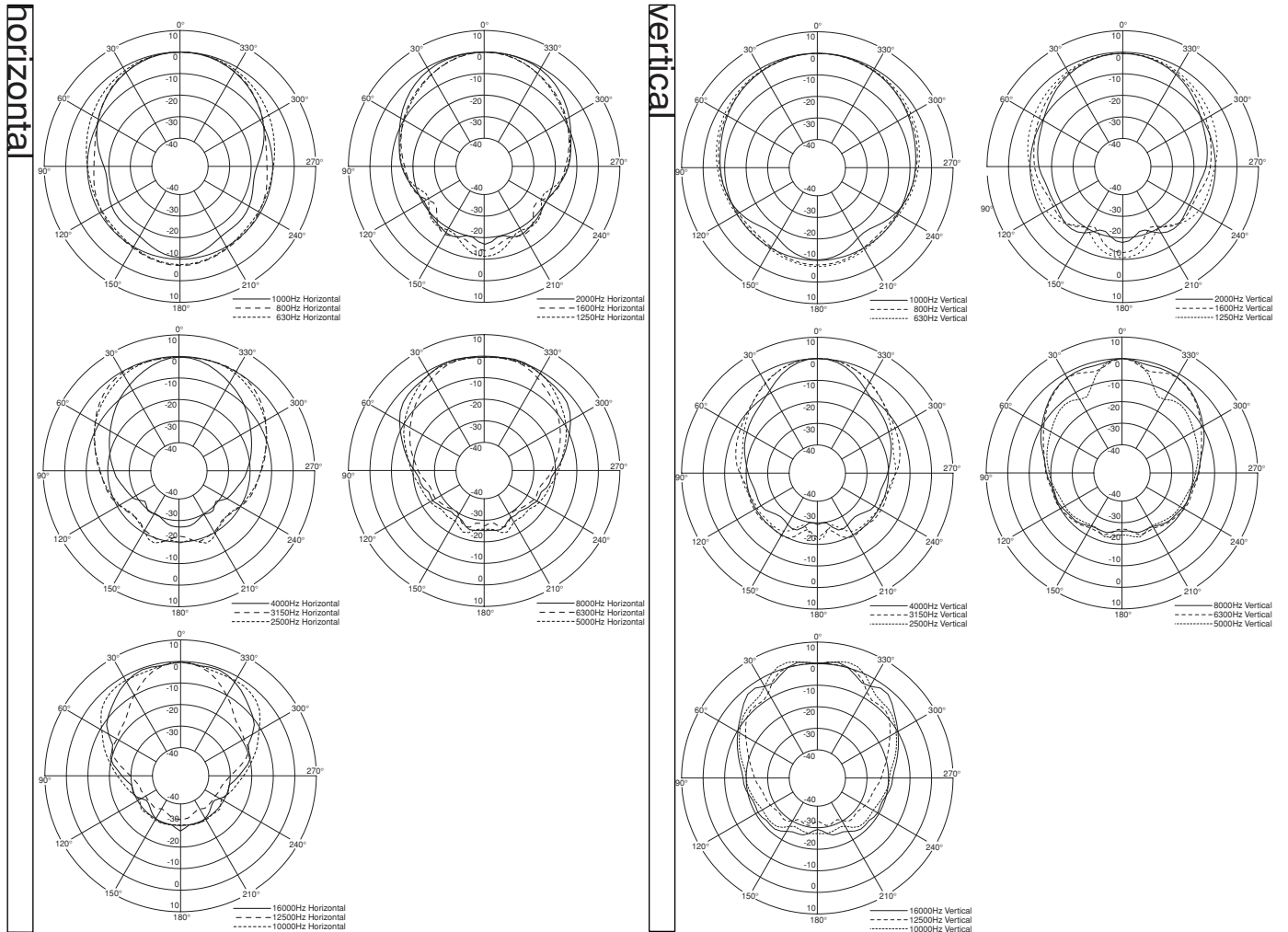

# CHARACTERISTIC DIAGRAMS

CS-304

Frequency Response(1W/1m:1/3 Octave Pink Noise)

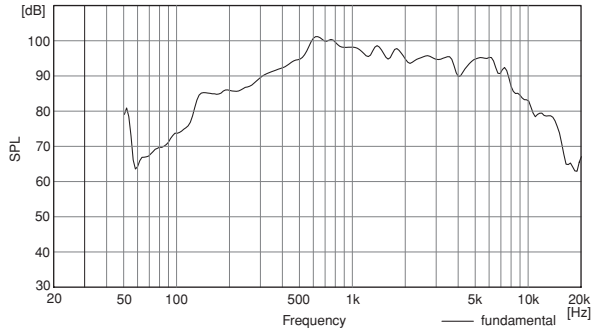

Beamwidth vs. Frequency

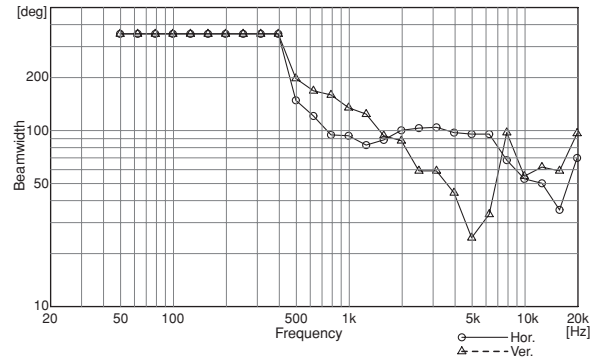

Directivity Factor vs. Frequency

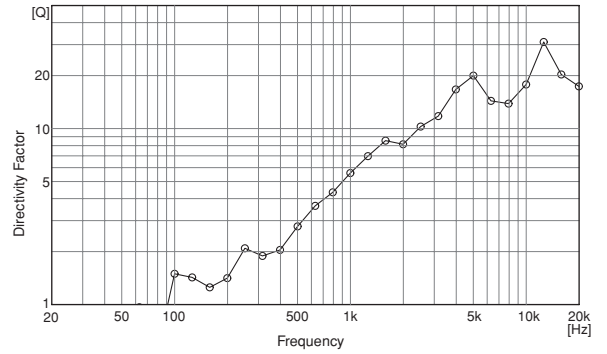

## Polar Response



## SPECIFICATIONS

Model No.	CS-154	CS-304
Rated Input	15W	30W
Rated Impedance	100V line: 670Ω (15W), 1kΩ (10W), 2kΩ (5W) 70V line: 330Ω (15W), 670Ω (7.5W), 1kΩ (5W), 2kΩ (2.5W)	100V line: 330Ω (30W), 500Ω (20W), 1kΩ (10W) 70V line: 170Ω (30W), 330Ω (15W), 500Ω (10W), 1kΩ (5W)
Sensitivity (1W, 1m)	97dB	98dB
Frequency Response	150 – 15,000Hz	120 – 15,000Hz
Speaker Component	12cm (4.72") cone-type	
Horizontal Directivity	Constant directivity horn 90° (±45° horizontal from front axis) 93dB or more (1W, 1m), 3kHz at ±45°	
Speaker Cord	2-core cabtyre cord with diameter of 6mm (0.24")	
Operating Temperature	-20°C to +55°C (-4°F to -131°F)	
Dust/Water Protection	IP65	
Finish	Horn, cover: ABS resin, off-white, paint Bracket: Stainless steel Net: Aluminum, gray, paint Screw: Stainless steel	
Dimensions	366 (W) × 230 (H) × 272 (D) mm (14.40" × 9.06" × 10.71")	
Weight	2.8kg (6.17 lb)	3.1kg (6.83 lb)

Note: Do not install the speaker face-up from a horizontal plane nor in such a way that the paper cone is exposed to direct sunlight.

If water accumulates on the paper cone, or ultraviolet rays are radiated on it, this may cause the paper cone to deteriorate, leading to speaker malfunction.

## ARCHITECTURAL AND ENGINEERING SPECIFICATIONS

The speaker shall be a wide-range weatherproof horn speaker suitable for paging, background music and tone signaling distribution. The speaker component shall be a 12 cm (4.72") cone-type speaker, treated for weather-resistance. Rated input shall be 15 W. The speaker shall include a transformer having multiple taps (5W, 10W, 15W at 100 V and 2.5W, 5W, 7.5W, 15W at 70V). The sensitivity at a distance of 1m with a 1W input level applied shall be 97 dB. The speaker shall have a frequency response of 150 - 15 kHz. Horizontal and vertical dispersion at -6 dB below the on-axis reference at 2 kHz shall be 110° (H) x 85° (V).

The speaker shall have a IEC 529 splash-proof rating of IP65. The speaker shall have an operating temperature of -20° C to +55° C (-4° F to 131° F). The speaker enclosure shall be constructed of ABS resin and coated with polyurethane resin paint to resist long-term exposure to ultraviolet light. The grille shall be constructed of a protective aluminum net to prevent damage, gray paint. All mounting hardware, including screws and bolts, shall be stainless steel, which protects the speaker from corrosion. The wide-range weatherproof paging horn shall include an integral speaker cable, 2-core cabtyre cord with diameter of 6 mm (0.24") diameter.

Dimensions shall be 366(W) × 230(H) × 272(D) mm (14.40" × 9.06" × 10.71"). Weight shall be 2.8 kg (6.17 lb.).

The wide-range weatherproof horn speaker shall be TOA model CS-154.

The speaker shall be a wide-range weatherproof horn speaker suitable for paging, background music and tone signaling distribution. The speaker component shall be a 12 cm (4.72") cone-type speaker, treated for weather-resistance. Rated input shall be 30 W. The speaker shall include a transformer having multiple taps (10W, 20W, 30W at 100 V and 5W, 10W, 15W, 30W at 70V). The sensitivity at a distance of 1m with a 1W input level applied shall be 98 dB. The speaker shall have a frequency response of 120 - 15 kHz. Horizontal and vertical dispersion at -6 dB below the on-axis reference at 2 kHz shall be 100° (H) x 85° (V).

The speaker shall have a IEC 529 splash-proof rating of IP65. The speaker shall have an operating temperature of -20° C to +55° C (-4° F to 131° F). The speaker enclosure shall be constructed of ABS resin and coated with polyurethane resin paint to resist long-term exposure to ultraviolet light. The grille shall be constructed of a protective aluminum net to prevent damage, gray paint. All mounting hardware, including screws and bolts, shall be stainless steel, which protects the speaker from corrosion. The wide-range weatherproof paging horn shall include an integral speaker cable, 2-core cabtyre cord with diameter of 6 mm (0.24") diameter.

Dimensions shall be 366(W) × 230(H) × 272(D) mm (14.40" × 9.06" × 10.71"). Weight shall be 3.1 kg (6.83 lb.).

The wide-range weatherproof horn speaker shall be TOA model CS-304.